

**2017 - 2023  
Dodge RAM  
6.7L Cummins  
Diesel Trucks**



**Ventech** 

**LHG (Liquid Heat Generator)**

**INSTALLATION MANUAL  
Ventech Kit # 0405**

2023-08-25

# Table of Contents

<b>1. Kit Overview.....</b>	<b>4</b>
1.1 Kit Diagram and Part Descriptions.....	4
1.2 Identification Sizing Table.....	8
<b>2. Tools We Used.....</b>	<b>10</b>
<b>3. Before you begin.....</b>	<b>12</b>
3.1 Best Practices.....	12
3.1.1 Fastener Torque.....	12
3.1.2 Use Threadlock – (Loctite).....	12
<b>4. About the Ventech HeatStroke LHG.....</b>	<b>12</b>
<b>5. Preparing for Installation.....</b>	<b>13</b>
5.1 Build the LHG Bracket Assembly.....	15
<b>6. Mechanical Installation.....</b>	<b>17</b>
6.1 Install the LHG Assembly.....	17
6.2 Install the Pulley.....	19
6.3 Attach the remaining part of the Coolant Hose Bracket to the LHG Assembly.....	20
6.4 Reinstall the Fan Shroud Bracket.....	20
6.5 Install the New Serpentine Belt.....	22
6.6 Attach the LHG to the Water Jacket.....	22
6.7 Prepare and Install the LHG Wiring Harness.....	24
6.8 Reconnect both batteries.....	32
6.9 Attach the LHG Wiring Harness to the driver side battery.....	32
6.10 Secure the Wiring Harness.....	32
6.11 Replace the Intake and the Fan/Intake Cover.....	32

**7. Final Inspection .....33**

**8. Initial Start-up .....34**

**Appendix A: The LHG ECU (Digital Controller) Strategy .....35**

    Understanding the ECU LEDs during Normal Operation  
    and as a Diagnostic Tool. .... 35

1. Kit Overview

1.1 Kit Diagram and Part Descriptions

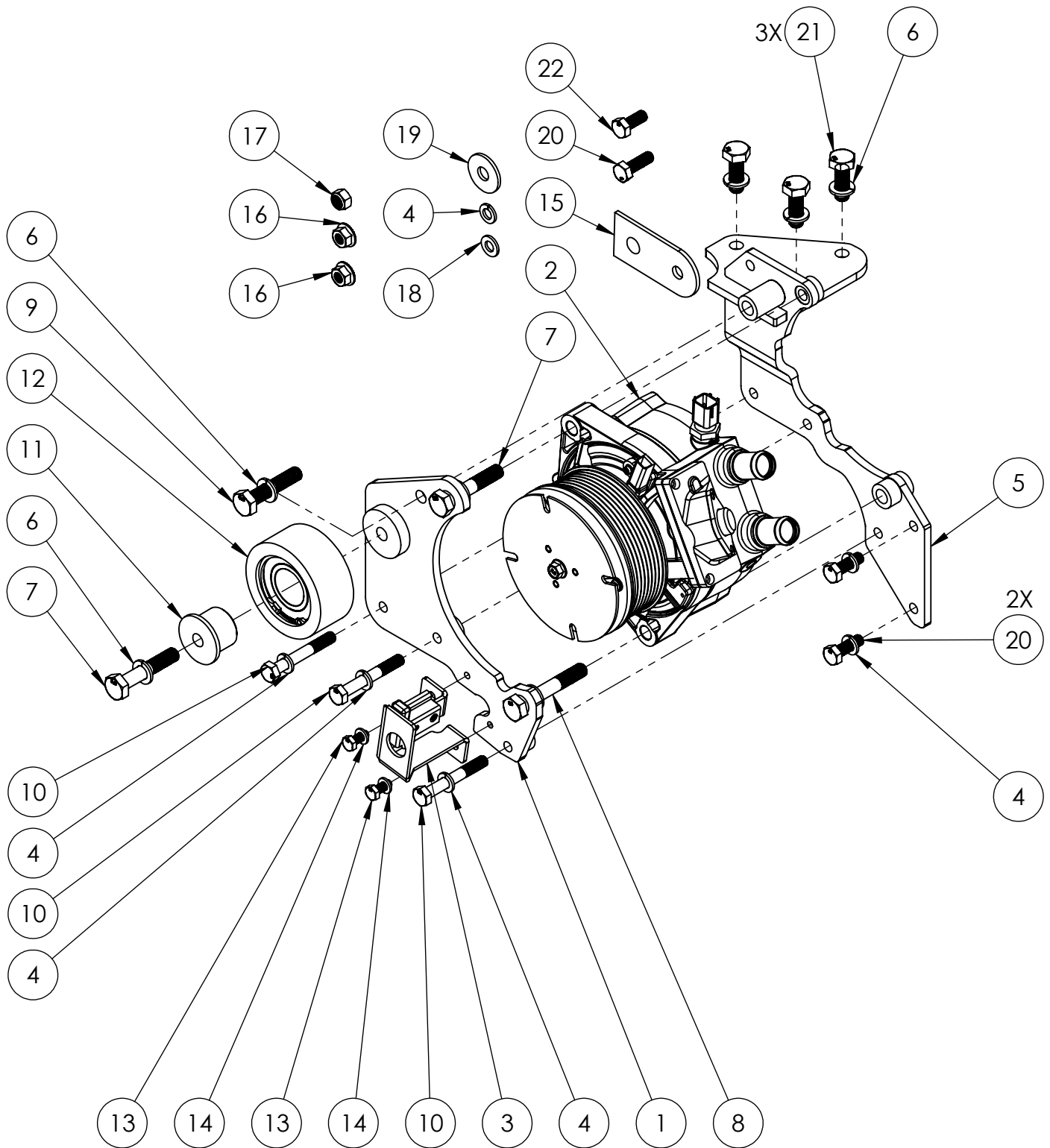



ITEM NO.	PART NUMBER	DESCRIPTION	QTY.
1	14-0576	KIT 405 - FRONT BRACKET	1
2	LHG700 DSS 58	LHG700 5/8 PORTS DUAL SPEED SENSOR	1
3	140-0155	LHG700/800 ROTOR RPM BRACKET ASS'Y (STANDARD)	1
4	925-0012	M8 LOCK WASHER	6
5	14-0577	KIT 405 - BACK BRACKET	1
6	925-0016	M10 LOCK WASHER - ZINC PLATED	5
7	920-0012	M10-1.5 X 55 HEX HD BOLT - 8.8 - ZINC PLATED	2
8	920-0911	M10-1.50 X 65 HEX HD BOLT - 8.8 - ZINC PLATED	1
9	920-0011	M10-1.5 X 50 HEX HD BOLT - 8.8 - ZINC PLATED	1
10	920-0134	M8-1.25 X 60 HEX HD BOLT - 8.8 - ZINC PLATED	3
11	14-0574	BEARING BUSHING (30MBB406)	1
12	14-0575	KIT 405 - 75MM IDLER PULLEY (75MBSIP)	1
13	920-0268	M6-1.0 X 15 HEX HEAD BOLT - 8.8 - ZINC PLATED	2
14	925-0020	M6 LOCK WASHER	2
15	14-0587	KIT 505 - STATOR OFFSET TAB	1
16	920-0257	"M8-1.25 SERRATED FLANGE HEAD NUT - CLASS 8 - ZINC PLATED"	2
17	920-0031	M8-1.25 NYLOC NUT	1
18	925-0002	M8 FLAT WASHER	1
19	925-0031	M10 OVERSIZED WASHER - ZINC PLATED	1
20	920-0010	M8-1.25 X 25 HEX HD BOLT - 8.8 - ZINC PLATED	3
21	920-0020	M10-1.5 x 30 HEX HD BOLT - 8.8 - ZINC PLATED	3
22	920-0009	M8-1.25 x 20 HEX HD BOLT - 8.8 - ZINC PLATED	1

Continued on page 7

Kit and Part Descriptions continued



The items listed below do not appear in the exploded diagram on page 4.

ITEM NO.	PART NUMBER	DESCRIPTION	QTY.
23	980-0083	SERPENTINE BELT, 8 RIB, 133.1" (GOODYEAR 1081331)	1
24	135-0041	ENHANCED DELUXE ECU, LIGHT/MEDIUM TRUCK	1
25	990-0108	5/8 HOSES (60") RIGHT ANGLE	2
26	14-0579	VELCRO STRIPS 4" X 3/4"	2
27	990-0002	8" NYLON TIE WRAPS	8
28	990-0093	SAE #12 WORM DRIVE HOSE CLAMP	4
29	135-0042	SWITCH ASSEMBLY, W/ PIGTAIL	1
30	130-0049	DELUXE ECU HARNESS ASSY, DUAL RPM SENSOR	1
31	990-0012	LOC-TITE (BLUE)	1
32	95-0060	FUSE TAP, ATR, 10A MAX	1
33	96-0034	ATR-5 AUTOMOTIVE ATR FUSE, 5A, 32VDC	
34	990-0091	5/8 HOSE ADAPTOR / CONNECTOR	1
35	96-0034	ATR-5 Automotive ATR Fuse, 5A, 32VDC	1

## 1.2 Identification Sizing Table

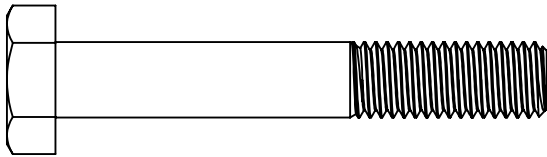

M10-1.5 X 65mm HEX BOLT  
920-0911 (1)

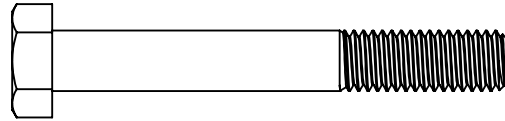

M8-1.25 X 60mm HEX BOLT  
920-0134 (3)

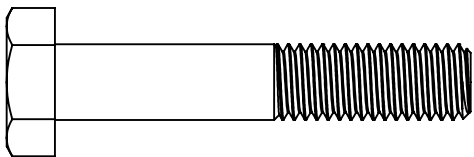

M10-1.5 X 55mm HEX BOLT  
920-0012 (2)

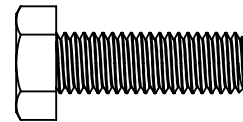

M8-1.25 X 25mm HEX BOLT  
920-0010 (3)

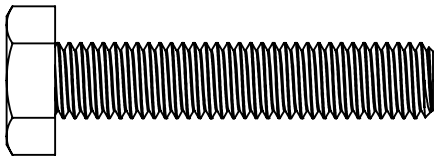

M10-1.5 X 50mm HEX BOLT  
920-0011 (1)

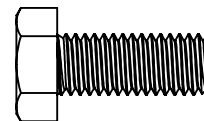

M8-1.5 X 20mm HEX BOLT  
920-0009 (1)

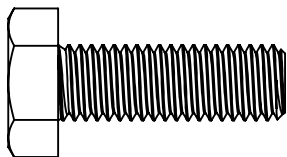

M10-1.5 X 30mm HEX BOLT  
920-0020 (3)

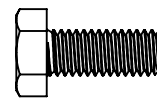

M6-1.0 X 15mm HEX BOLT  
920-0268 (2)

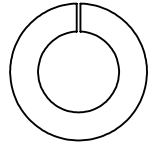

M10 LOCKWASHER  
925-0016 (5)

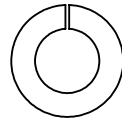

M8 LOCKWASHER  
925-0012 (6)

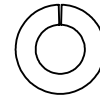

M6 LOCKWASHER  
925-0020 (2)

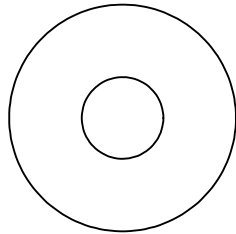

M10 OVERSIZED WASHER  
925-0031 (1)

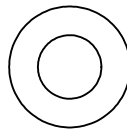

M8 FLAT WASHER  
925-0002 (1)

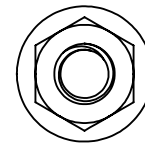

M8 X1.25 SERRATED  
FLANGE NUT  
920-0257 (2)

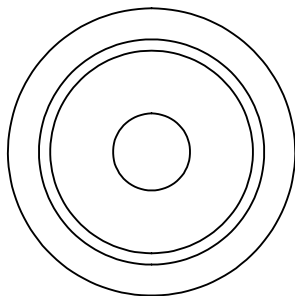

BEARING BUSHING  
14-0574 (1)

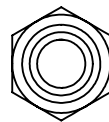

M8 X 1.25 NYLOC NUT  
920-0031 (1)





Breaker Bar

1/2" Drive

1/2" drive Extension 1"

Torque Wrench

3/8 Drive Pear Head Ratchet

1/4 Drive Pear Head Ratchet

1/4 Drive Extension 6"

13mm Deep Well Socket

8, 10, 13 & 17mm Short Well Socket

13mm wrench

8" Pliers

Needle Nose Pliers  
or Fuse Removal Tool

10" Flat Head Screwdriver

Hose Cutter

Nippers

Wire Cutters

Wire Stripper

Crimper

Gap/Feeler Gauge

### 3. Before you begin

Before you begin the installation, check the Kit Parts List against the content of the Installation Kit. If anything is missing or incorrect, contact Ventech immediately.

#### 3.1 Best Practices

It is very important that the LHG be installed correctly not only to obtain maximum results, but also to minimize the possibility of unit failure. The following tips address some of the more common installation mistakes.

##### 3.1.1 Fastener Torque

Torque all fasteners according to the instructions in this manual. Excessive fastener torque may cause damage to the bolts and/or threaded components. Too little torque may cause fasteners to loosen.

##### 3.1.2 Use Threadlock – (Loctite)

Loctite 243 must be applied when and where noted in this manual.

### 4. About the Ventech HeatStroke LHG

The heart of the Ventech HeatStroke Rapid Supplemental Heater System is the proprietary Liquid Heat Generator (LHG).

By providing fast engine and cabin wamup, your engine will spend far less time “running cold,” saving fuel, and reducing wear & tear on the engine, various engine components, and after-treatment system.

The LHG generates coolant heat by the rotation of an internal ‘rotor’ opposing a stationary ‘stator’ within the LHG Heater assembly. Fluid friction is caused by a process known as toroidal vortexing or the shearing of toroidal vortices. The process is highly efficient (up to 98%) and instantaneous.

The digital ECU provided with the Ventech system determines when to activate the LHG, based on Coolant Temperature, Vehicle Voltage, Engine and LHG RPM, Ambient Air temperature, and other parameters monitored by the ECU.

The system is a fully automatic belt-driven vehicle accessory. A dashboard switch is provided for manual enable and disable of the system from within the cab.

## IMPORTANT!!

**Before beginning,  
disconnect both batteries.**

**While this installation can be completed by one person, we have found it advantageous to have assistance especially when installing the LHG assembly and when removing and installing the serpentine belt.**

## 5. Preparing for Installation

1. Remove Radiator Support Cover.



2. Remove Air Inlet.

Place a clean rag in the open air intake on the engine to prevent things from accidentally falling into it.



3. IF DESIRED add a guard to the fan shroud.

We found the fan shroud to be very sharp and added a piece of weather stripping to provide some protection for our arms.



4. Remove the serpentine belt.

Using the breaker bar and 1/2" drive extension, release the tension on the serpentine belt and remove it.

**NOTE:** We have found the hardest part of this process to be getting the belt around behind the tensioner. Twisting and slipping the belt behind the tensioner is easier and safer when the tensioner is in its resting position.





5. Disconnect the top Coolant Hose Bracket

Unbolt the Hose Bracket from the engine.

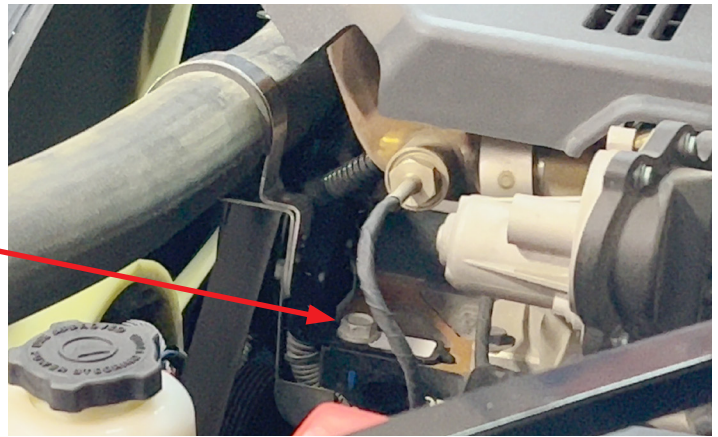

Also, Remove the Coolant Hose Bracket Extension shown here.

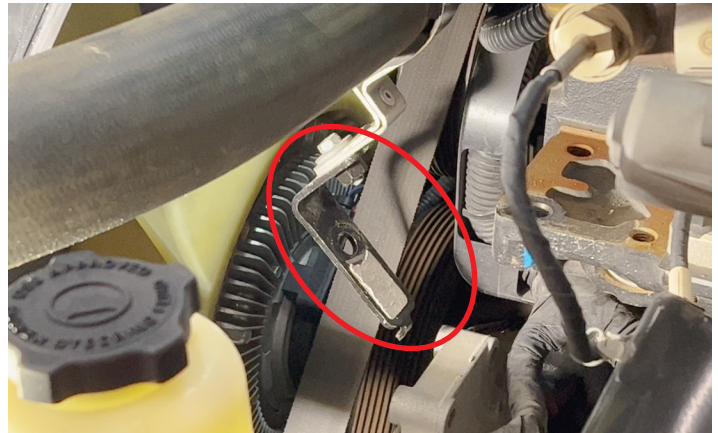

6. Remove the Fan Shroud Bracket.

Save the bracket, and the nut shown here, for use later.

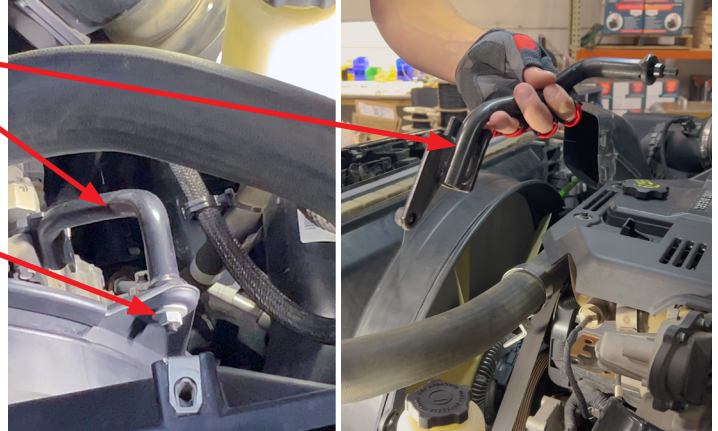

7. Secure the "rogue bolt" if necessary.

During some of our installations, we encountered this bolt for the bracket that could not be easily removed.

This bolt will not be used for the LHG install. If you can't remove it during your installation we have supplied an M8-1.25 Serrated Flange Head Nut (part #920-0257) to be used to secure it as shown here.





- Pry out the Wiring Mount shown here to make room for the LHG Bracket.

**NOTE:** The bracket will fit in front of the wiring where the mount was attached.  
**Be careful not to pinch the wiring when mounting the LHG bracket.**

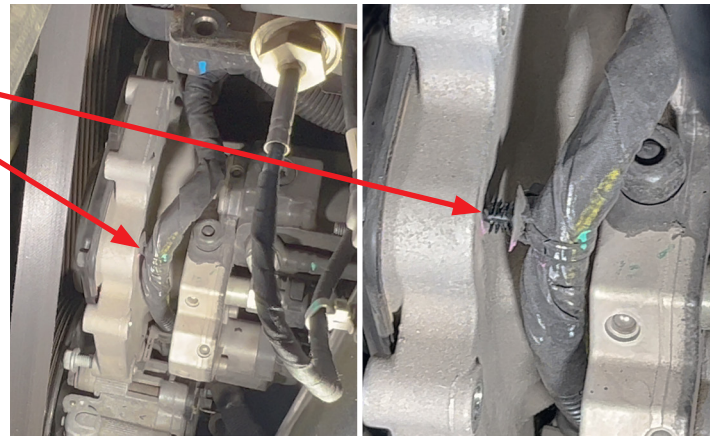

### 5.1 Build the LHG Bracket Assembly.

Locate the installation kit items listed in the table to the below.

Part #	Description	Qty
LHG700 DSS 58	LHG	1
14-0576	FRONT BRACKET	1
14-0577	BACK BRACKET	1
140-0155	ROTOR RPM BRACKET ASSY	1
920-0268	M6 1.0 X 15 Hex Head Bolts	2
925-0020	M6 Lock Washers	2
920-0012	M10 1.5 X 55 Hex Head Bolt	1
920-0191	M10 1.5 X 65 Hex Head Bolt	1

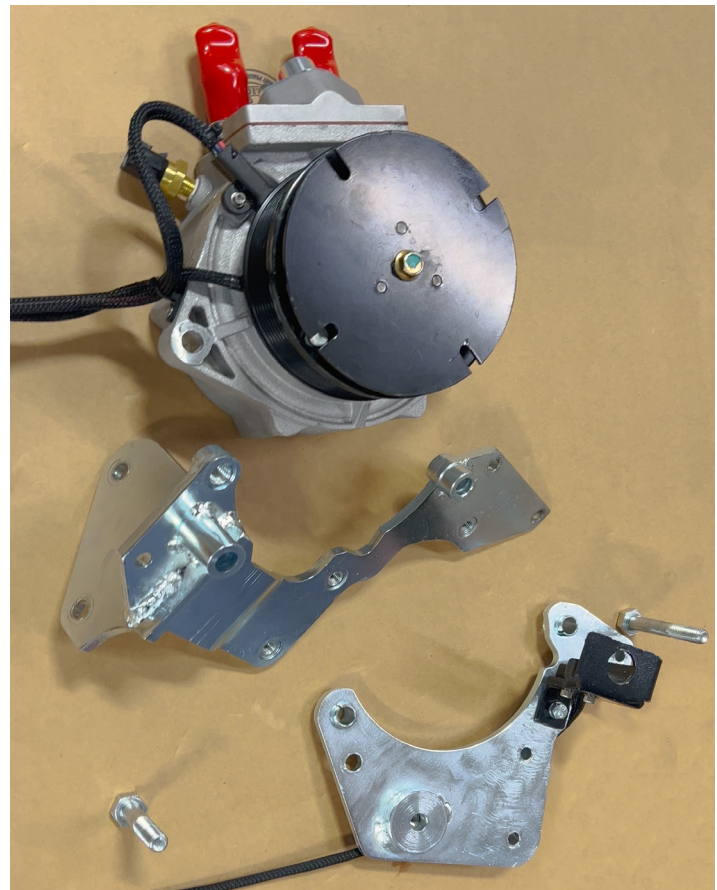

#### 5.1.1 Attach LHG Rotor RPM Bracket Assembly to the Front Weldment

- Position the RPM Sensor Bracket Assembly as shown here and bolt it in place using two M6 1.0 X 15 Hex Head Bolts (part #920-0268) and two M6 Lock Washers (part #925-0020).

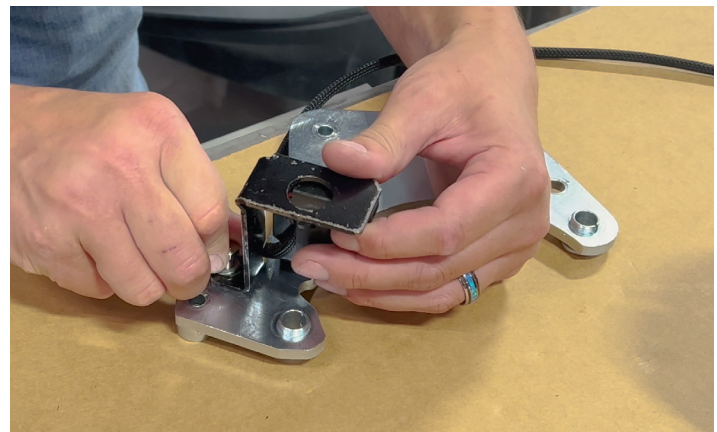

10. Torque the bolts.

 Torque both bolts to 11 Nms or 8 ft-lbs.

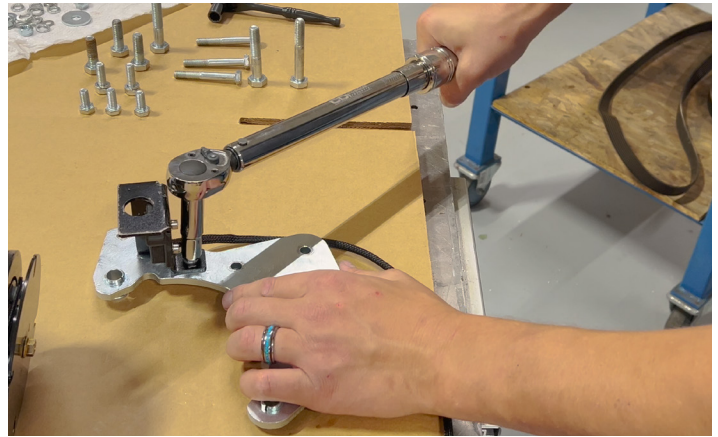

### 5.1.2 Complete the Bracket Assembly

 Using Loctite on the threads of the M10 1.5 X 65 Bolt (part #920-0191) and the M10 1.5 X 55 Bolt (part #920-0012)

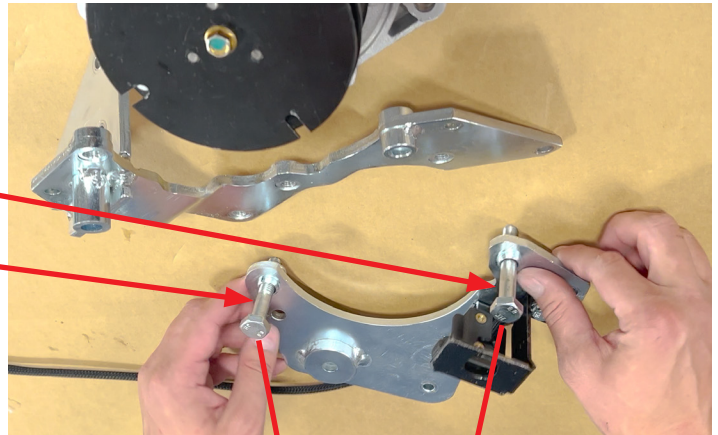

11. Complete the LHG Bracket Assembly as shown.

**Note the cable position.**

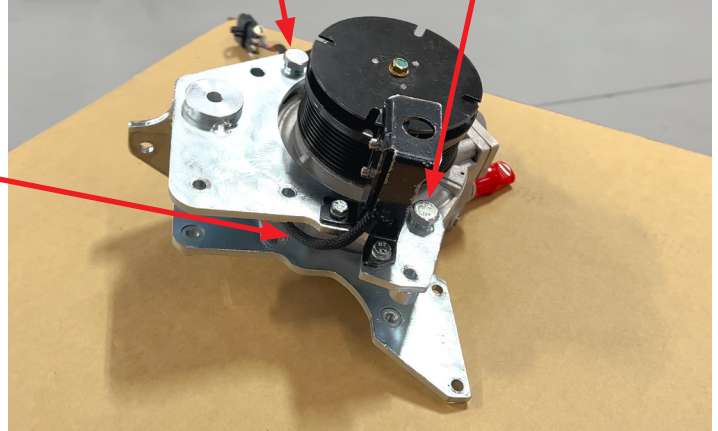

Verify the RPM Sensor cable is routed as shown, between the LHG and the spacer without being pinched.

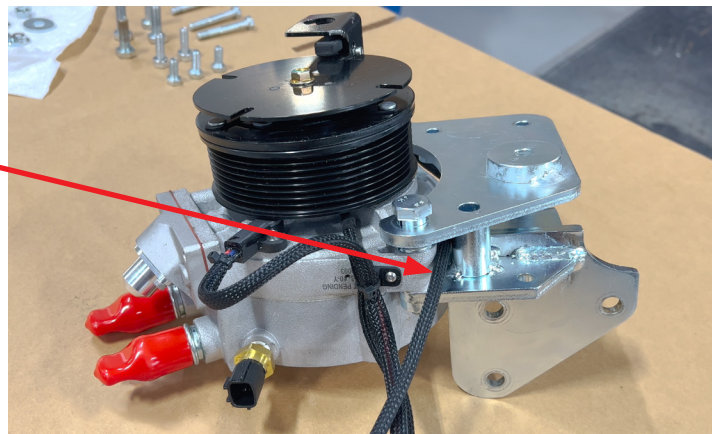



12. Torque the LHG Bracket.



Torque the LHG Bracket assembly bolts to 55 Nms or 40 ft-lbs.

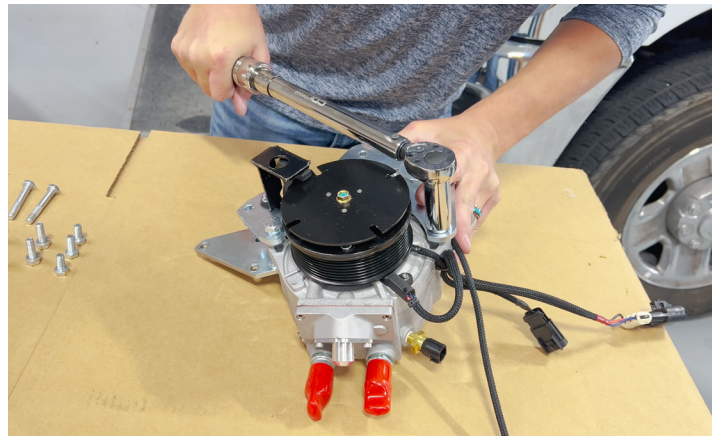

5.1.3 Check RPM Sensor Gap

13. Using a .020" or 0.5mm feeler gauge, check the air gap between the RPM sensor and the LHG speed disc.

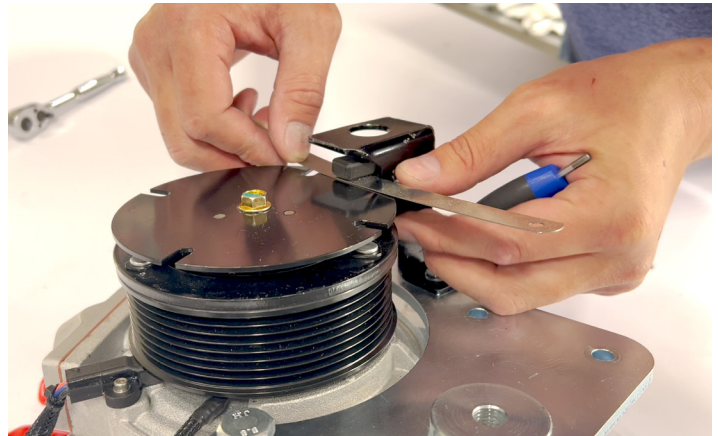

If the gap is too large or too small, loosen the 2 bolts on the side of the Rotor RPM Bracket, set the gap properly to .020" or 0.5mm, and re-tighten.

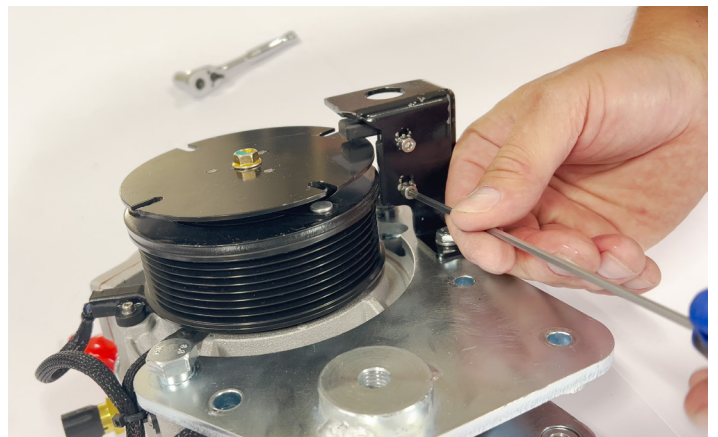

6. Mechanical Installation

6.1 Install the LHG Assembly.

**NOTE:** Be especially careful, the LHG Assembly is quite heavy and contains delicate parts that can be damaged during this process.

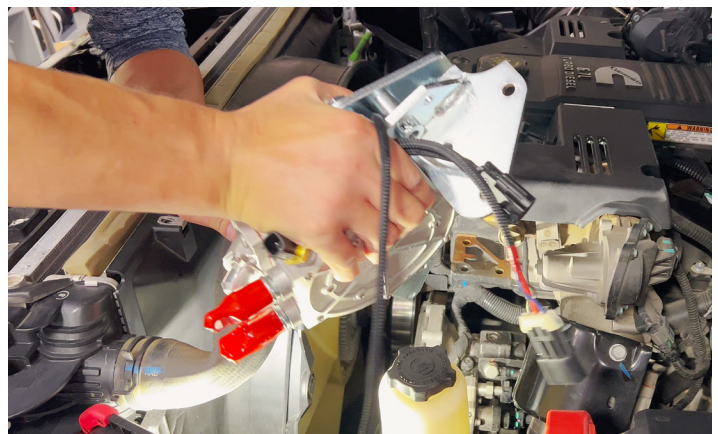

Move the coolant hose aside and lift the LHG Assembly into place.

**NOTE:** While one person can complete the LHG Assembly installation, **we suggest that you get assistance when mounting the LHG Assembly.**

- Use the three M10 1.5 X 30 Hex Head Bolts (part #920-0020) and three of the M10 Lock Washers (part #925-0016)

Rest the Assembly on the engine block, as shown here, while maintaining the weight of the assembly until the first bolt and washer are inserted.

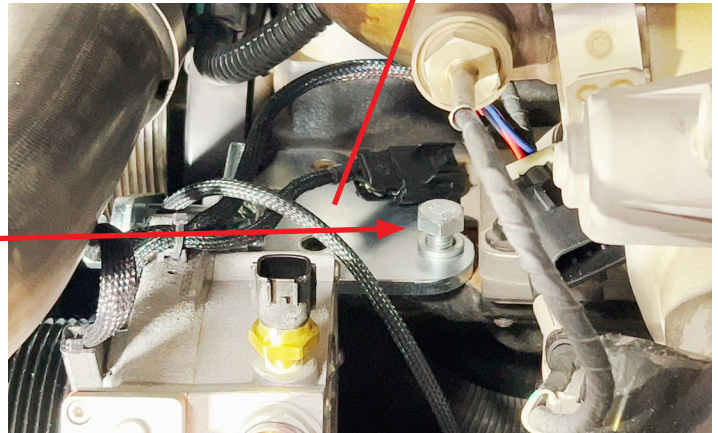
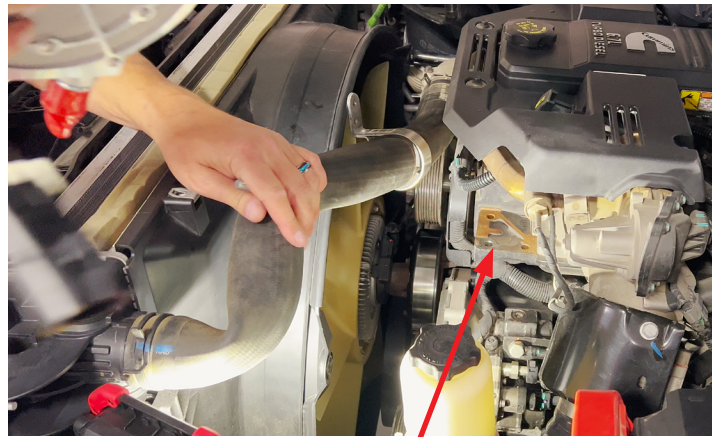

Leaving above bolt slightly loose, locate the following items:

Part #	Description	Qty
920-0011	M10 1.5 X 50 HEX HEAD BOLT	1
925-0016	M10 LOCK WASHER	1
920-0134	M8 1.25 X 60 HEX HEAD BOLT	3
925-0012	M8 LOCK WASHERS	3

- Install the above items to finger tight, using the image to the right (LHG Bracket Assembly with RPM Sensor Assembly Removed) to identify the location for each.

**M10 1.5 X 50 Hex Head Bolt and Lock Washer**

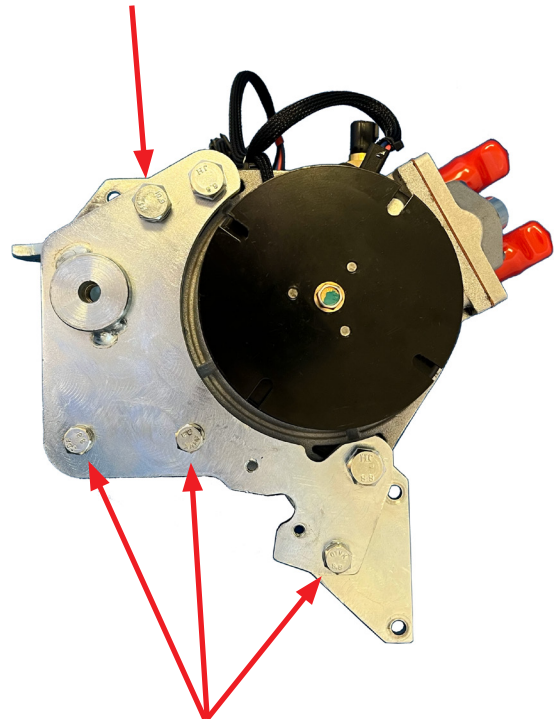



**M8 1.25 X 60 Hex Head Bolts and Lock Washers**



16. Install the remaining M10 1.5 X 30 Hex Head Bolts (part #920-0020) and M10 Lock Washers (part #925-0016) as shown here.



 Torque the bolts shown here to 55Nms or 40 ft-lbs.

 Torque the bolts shown here to 30Nms or 22 ft-lbs.

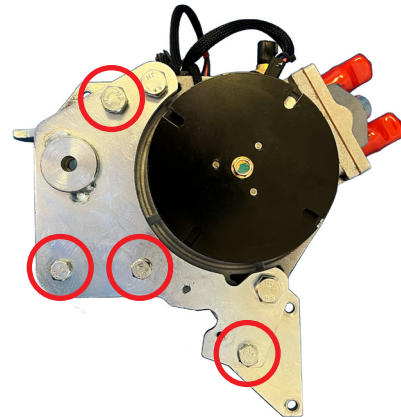

## 6.2 Install the Pulley

Locate the following parts:

Part #	Description	Qty
920-0012	M10 1.5 X 55 HEX HEAD BOLT	1
925-0016	M10 LOCK WASHER	1
14-0574	BEARING BUSHING	1
14-0575	75MM IDLER PULLEY	1



17. Install the pulley as shown to the right.

 Torque the bolt to 55Nms or 40 ft-lbs.

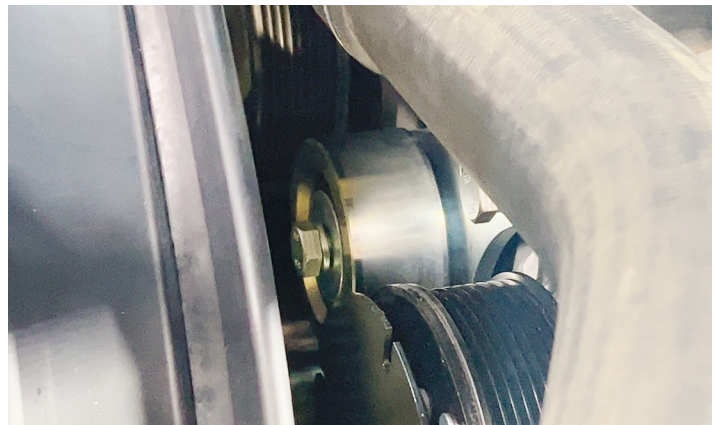



### 6.3 Attach the remaining part of the Coolant Hose Bracket to the LHG Assembly

18. Using an M8 1.25 X 20 Hex Head Bolt (part 920-0009) a M8 Lock Washer and an M8 1.25 Flange Nut (part #920-0257), attach the Coolant Hose Bracket as shown here, and tighten the bolt.

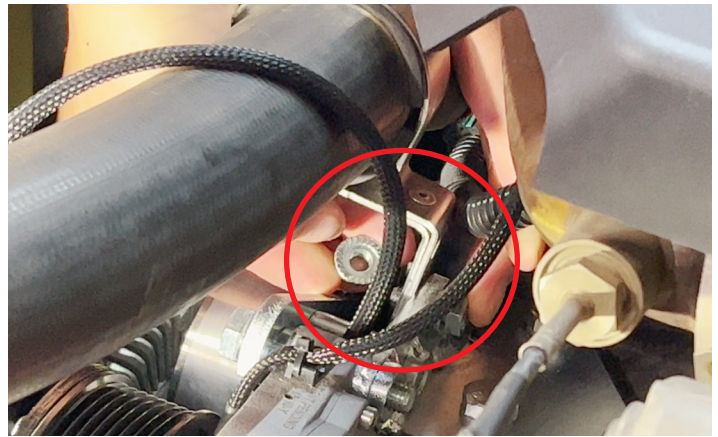

### 6.4 Reinstall the Fan Shroud Bracket.

Locate the following supplied parts:

Part #	Description	Qty
14-0587	STATOR OFFSET TAB	1
920-0010	M8 1.25 X 25 HEX HEAD BOLT	2
925-0002	M8 FLAT WASHER	1
925-0031	M10 OVERSIZED WASHER	1
920-0257	M8 X 1.25 SERRATED FLANGE NUT	1



The bottom (rounded end) of the Stator Offset Tab will be attached to the Fan Shroud at the location shown here.

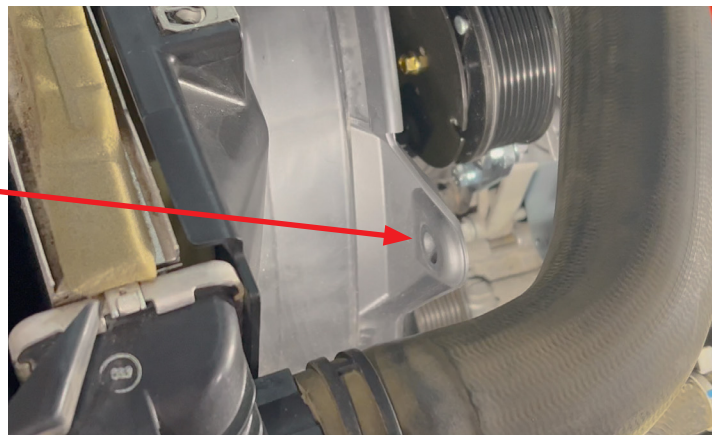

19. Leaving the connection slightly loose, attach the Stator Offset Tab to the shroud, as shown here.



Using the OEM nut saved when the bracket was removed (page 14 step 6)...

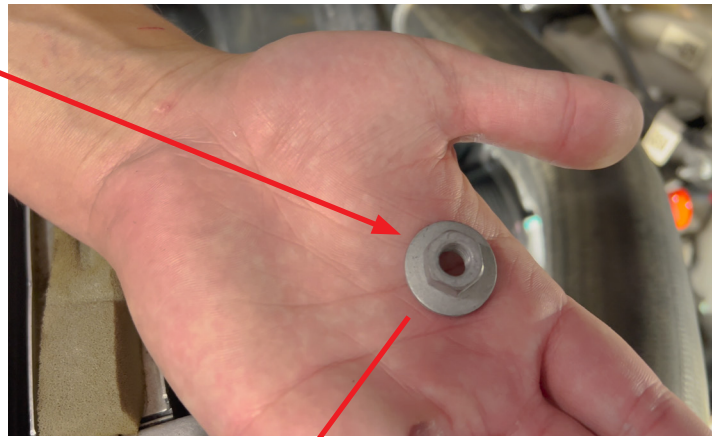

...attach the Shroud Bracket to the Stator Offset Tab, as shown here, leaving the connection loose.

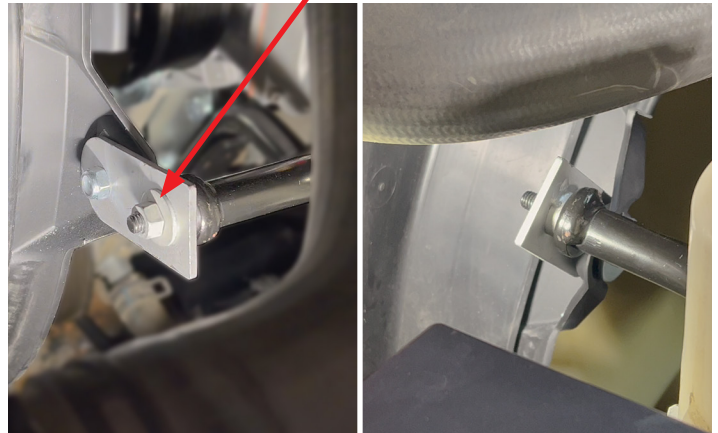

20. Using two M8 1.25 X 25 Hex Head Bolts (part 920-0010) and two M8 Lock Washers (part #925-0012) Attach the other end of the Shroud Bracket to the LHG Bracket Assembly.

For reference, and because it is difficult to get a good picture of the connection when installed on the engine, the illustrations on the right show how the Shroud Bracket looks when connected to the LHG Bracket.

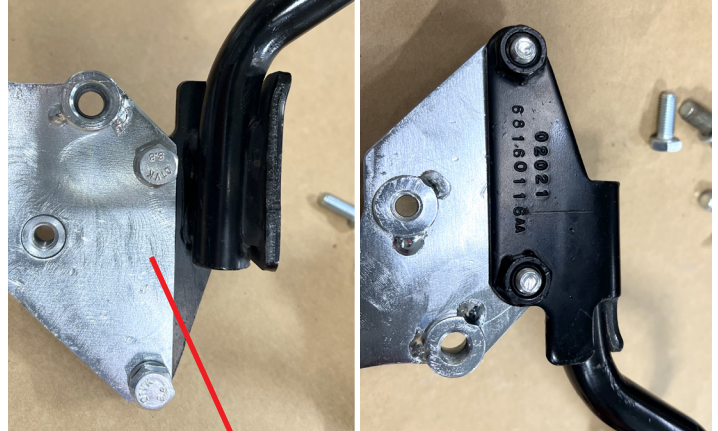

The illustration to the right shows the Shroud Bracket attached to the LHG Bracket and the Offset Tab in its final installed condition.



Torque the Bracket Bolts to 30Nms or 22ft-lbs.



Torque the Bracket Flange Nut to 30Nms or 22ft-lbs.



Torque the M8 Nyloc nut to 8Nms or 6ft-lbs



## 6.5 Install the New Serpentine Belt.

21. Using the diagram to the right, install the new serpentine belt (part #980-0083). We have found it easiest to have a second person help with routing the belt.

Begin by placing the belt around the tensioner. Then place the belt around the crankshaft, the fan, etc.

Wait to put the belt under the LHG Bracket mounted Pulley. (highlighted in the illustration). Save this pulley for last.

Once the belt is in place and you have double-checked, pull back on the tensioner, release as much tension as you can and carefully slip the belt under the LHG Bracket-mounted Pulley to complete the belt installation process.

Return tension to the belt, check to make sure it has not slipped off anywhere.

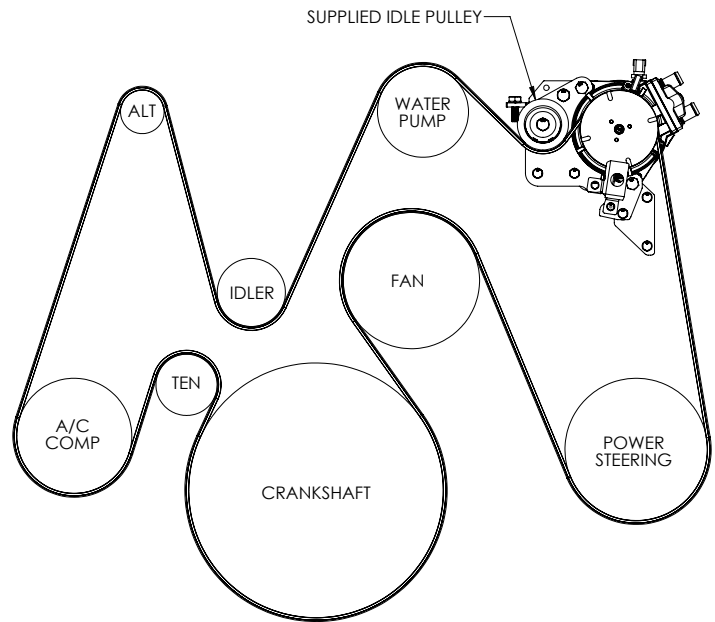

## 6.6 Attach the LHG to the Water Jacket

**IMPORTANT!** Make sure the engine is cold and there is no pressure or heat left in the coolant system.

While some coolant will be lost during this process, there is no need to drain the coolant. You may want to place something under the engine to collect the small amount of lost coolant.

Locate where the Heater Core input hose connects to the engine. Shown here.



22. Begin by releasing the clip and detaching the heater core input hose from the Quick Connect. Keep the clip on the hose for later use.

**LEAVE THE QUICK CONNECT IN PLACE.**

That is, do not disconnect the Quick Connect from the engine, simply detach the hose from the Quick Connect.



23. Using one of the supplied Worm Drive Hose Clamps (part #990-0093) attach the Hose Connector (part #990-0091) to the angled end of one of the coolant Hoses (part #990-0108).

Mark **both ends** of **ONLY THIS HOSE** for later reference (not where the hose clamps will go). Here we wrapped the ends with red duct tape (not included in the kit).

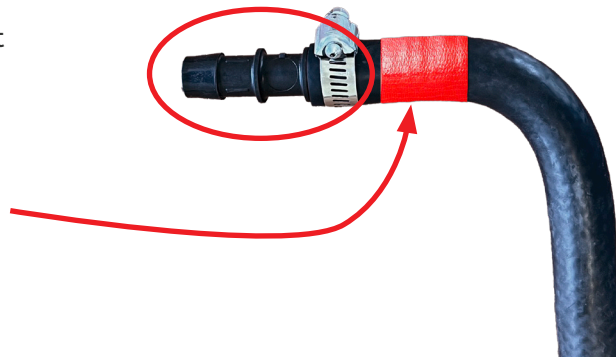

24. Starting with the straight ends of BOTH Hoses, route the supplied Hoses (part#990-0108) from the location of the Heater Core input hose you just disconnected, under the vent overhang and behind the wiring, into the opening on the driver side of the engine and up to the LHG.

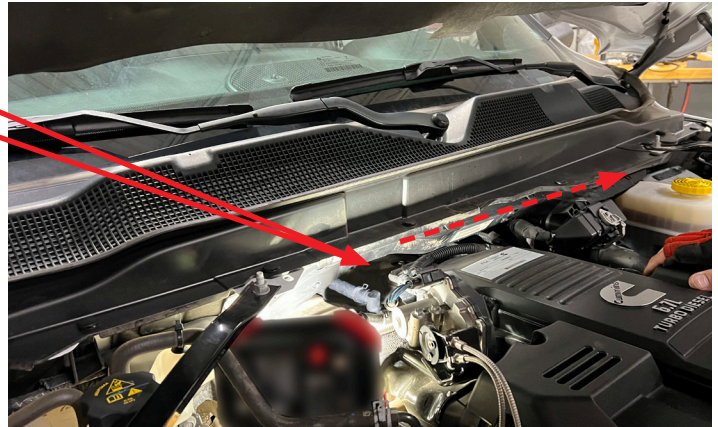

The dotted lines in both illustrations represent the hoses running behind the items shown.

25. Cut both hoses to length.

**IT IS IMPORTANT NOT TO KINK THE HOSES.**

MAKE SURE TO leave a reasonable amount of slack so the hoses will not be pulled tight or be kinked when the final connection to the LHG is made.

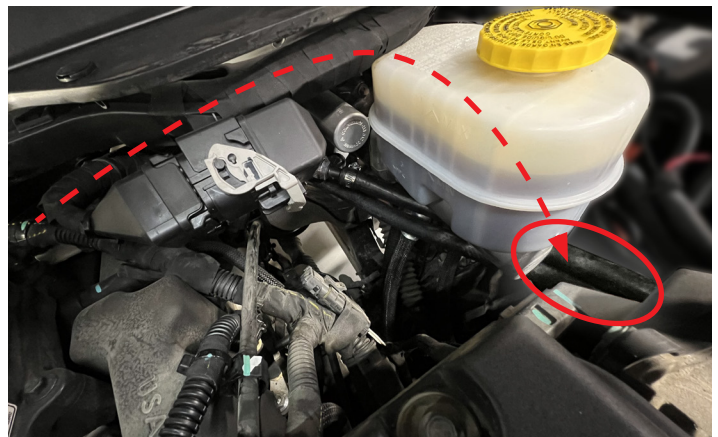

As an example, during our install the hoses came to about 52". However, your routing and requirements may vary, so we recommend trimming the hoses based on your individual install.

Re-mark the end of the marked hose if you will be cutting your earlier mark off.

**IT IS IMPORTANT NOT TO CONFUSE THE HOSES.**



26. Using the supplied Worm Drive Hose Clamps (part #990-0093), connect the marked hose to the LHG's output port (shown here on the left) and the unmarked hose to the LHG's input port (the one on the right).

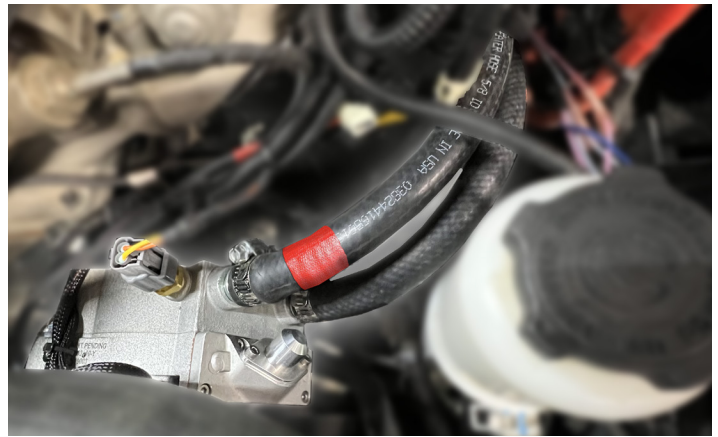

27. Using the Hose Clip that was originally holding it to the Quick Connect (hidden in the first picture), connect the truck's Heater Core Input Hose, which was disconnected from the Quick Connect earlier, to the Hose Connector that should already be on the marked Hose that goes to the LHG's output.

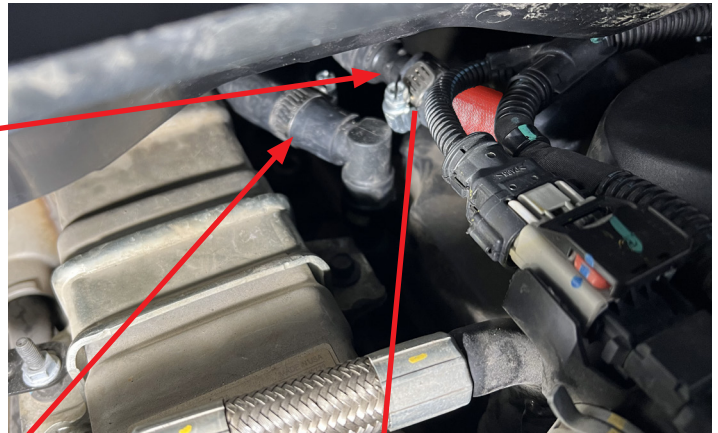

28. Using the remaining Worm Drive Hose Clamp (part #990-0093) connect the Quick Connect to the unmarked Hose that goes to the LHG's input.



### 6.7 Prepare and Install the LHG Wiring Harness.

Locate the LHG Deluxe ECU Wiring Harness (part #130-0049)





### 6.7.1 Connect the Wiring Harness to the LHG

29. Attach the connectors for the temperature sensor (Gray on the harness, black with brass directly mounted to the LHG).
30. Attach the connectors for the LHG clutch (both black connectors).

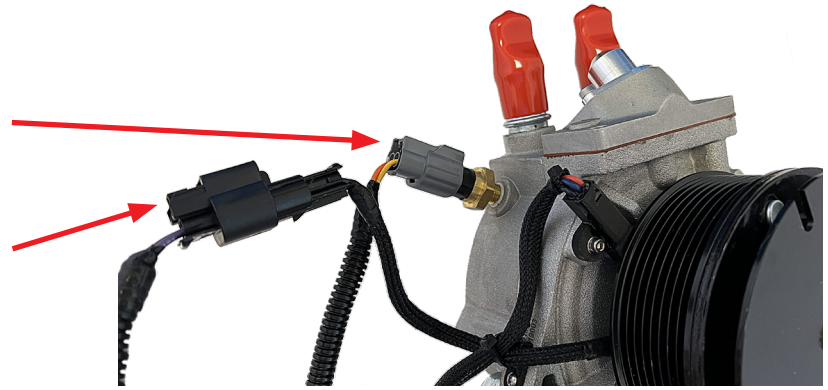

Locate the RPM sensor connections 2 female from the LHG and 2 male from the wiring harness.

These connectors are the same size and fit, but are shrink-wrapped with different colors (yellow and red) where the wires enter the insulation.

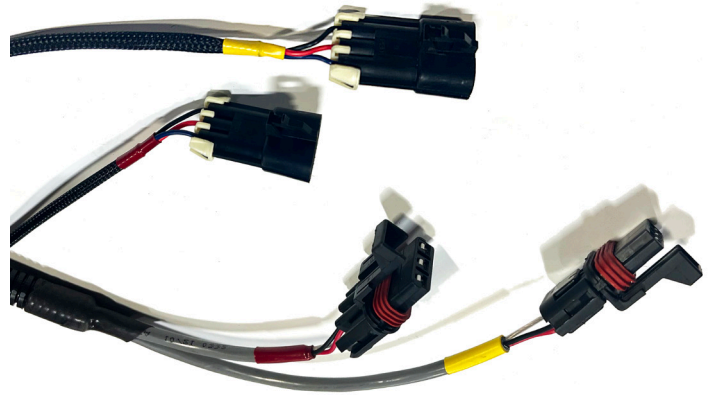

### 31. CONNECT YELLOW TO YELLOW AND RED TO RED.

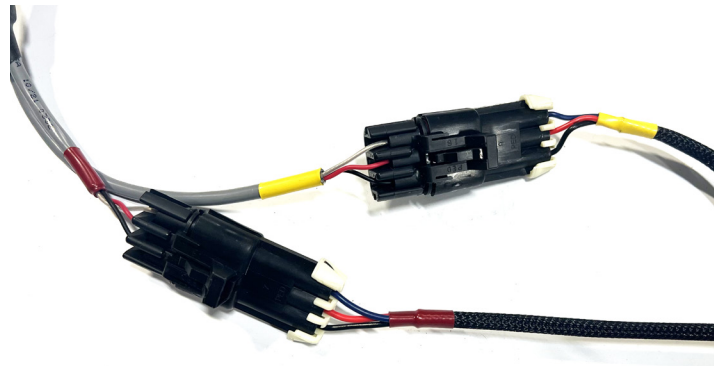

### 6.7.1 Attach and Mount the ECU

32. Attach the Enhanced Deluxe ECU (part #135-0041) to the Wiring Harness as shown here.

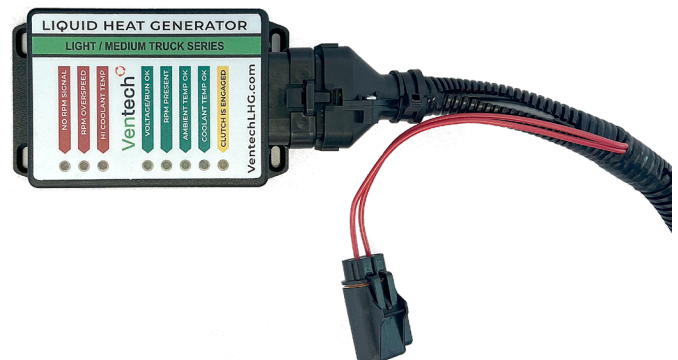

33. Using one of the options listed here, securely mount the ECU in the engine compartment.

Regardless of the mounting option you choose, make sure the ECU will not damage or be damaged by contact with the hood, or any other items under the hood.

**OPTION ONE:** Securely attach the ECU using two Nylon Ties as shown here.

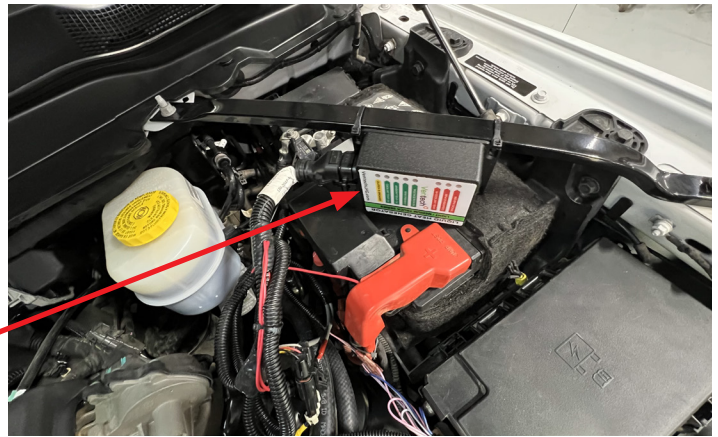

**OPTION TWO:** Using the Velcro Strips Provided (part #14-0579), securely attach the ECU to the cover of the electronics box at the back right of the engine compartment behind the battery, as shown here.

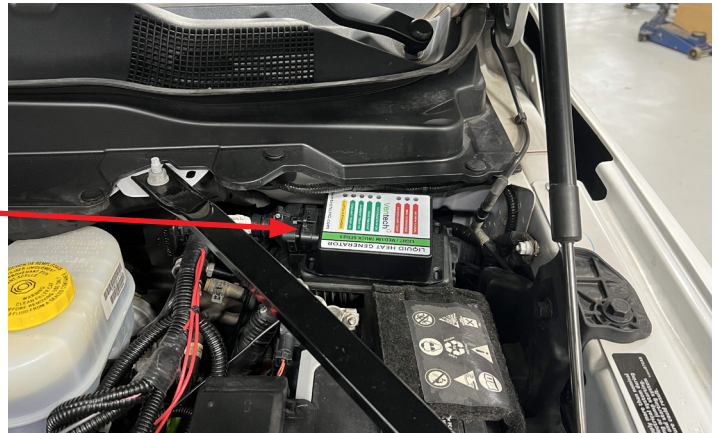

**OPTION THREE:** Using the Velcro Strips Provided (part #14-0579), securely attach the ECU to the cover of the fuse box at the right front of the engine compartment, in front of the battery, as shown here.

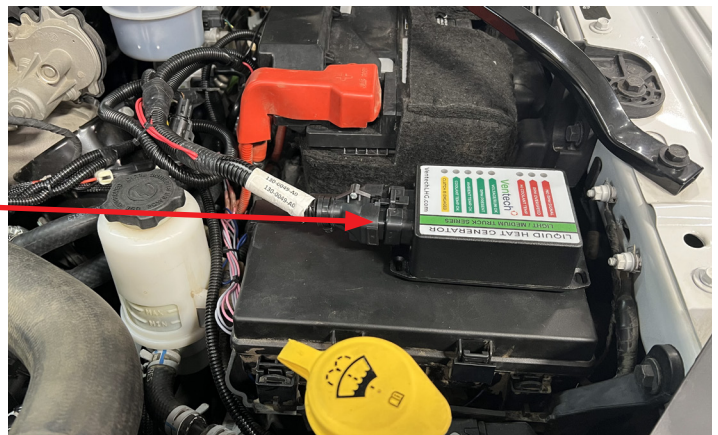

### 6.7.2 Position & Secure the OATS

On the wiring harness, locate the Outside Ambient Temperature Sensor (OATS).





34. Being careful to stay away from moving parts and hot objects, snake the sensor through the engine compartment to the underside of the truck - following a path similar to the path shown here.

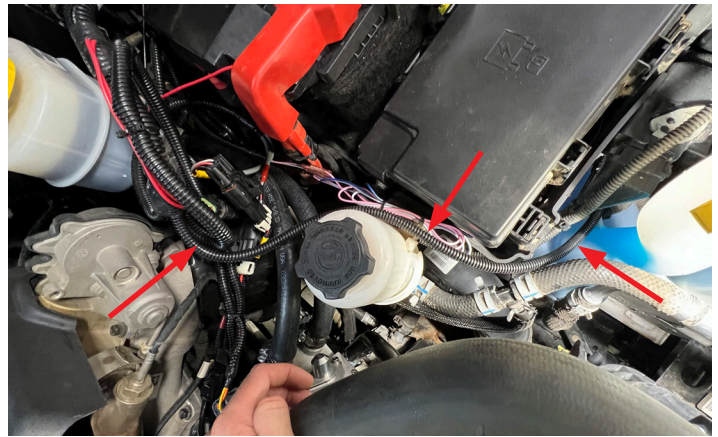

Route the OATS through the space shown here from above. . .

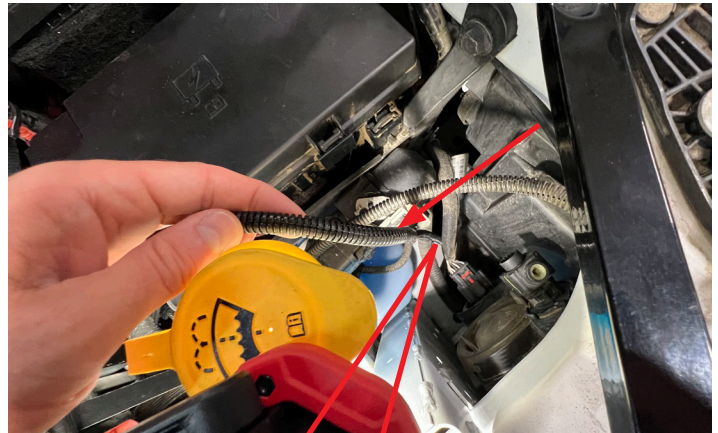

And here from under the truck.



35. Using the supplied Nylon Tie Wraps (part #990-0002) secure the ambient temperature sensor to a safe place behind the bumper, away from sources of heat and items that move or may rub against it.

Make sure the tip of the OATS is not touching any part of the truck.





### 6.7.3 Install the LHG Switch in the Cab

Locate the Switch Assembly  
(part #135-0042)



36. Remove the locking nut from the Switch Assembly, unthread it from the wires, and save it for later.

Thread the wires through the hole you drilled for the switch and reinstall and tighten the locking nut to hold the switch in place.



37. Mount the switch on the dash as shown.

Remove the dash cover piece.

Using a cone drill, or a 5/8 or 16mm drill bit, carefully drill a hole for the switch at the target location, where the switch will fit down through the dash frame.

If using a standard drill, you should drill a pilot hole first.

Thread the switch wires through the hole you drilled and reinstall and tighten the locking nut to hold the switch in place.



38. Locate the Firewall pass-through.



Shown here, under the dash on the inside . . .

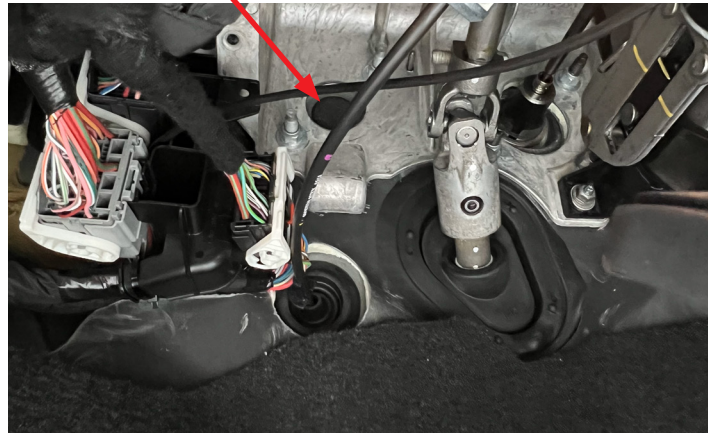

Found here within the engine bay.

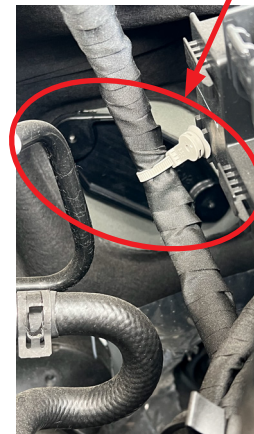
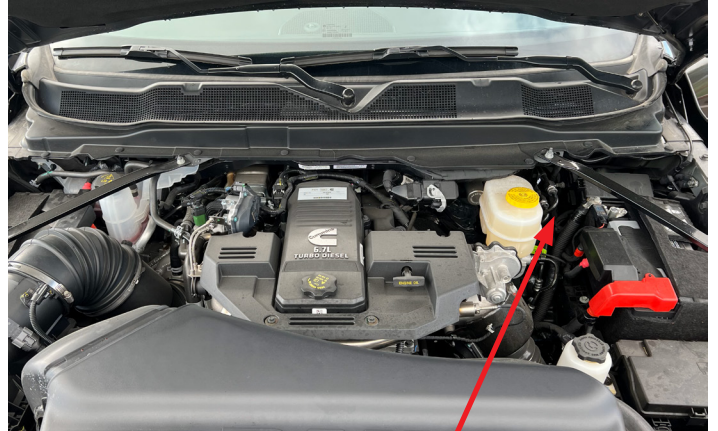



39. Remove the pass-through cover or drill an appropriate access hole and run the switch wiring through. Be careful to avoid moving and sharp items under the dash.

Use the Nylon Ties provided to secure the Switch Wire under the dash.



Now that the three ends of the Switch Wiring (pink, gray and blue) are in the engine compartment, locate the pink and gray wires on the LHG Wiring Harness.

The pink and gray wires on the Wiring Harness will have crimp butt splicers already installed on them

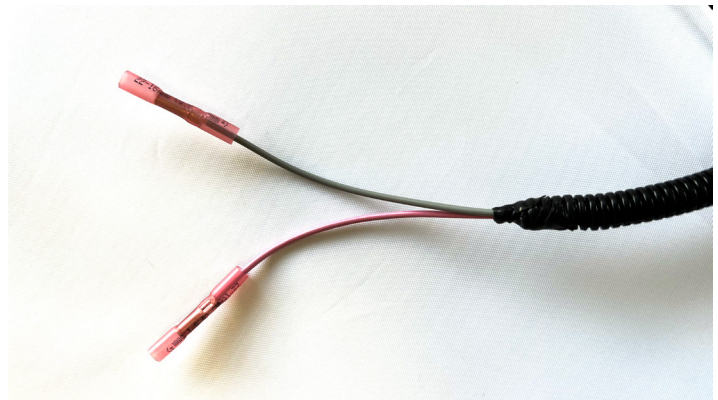

40. Strip approximately 1/4" of the insulation from the ends of the pink and gray wires from the Switch.

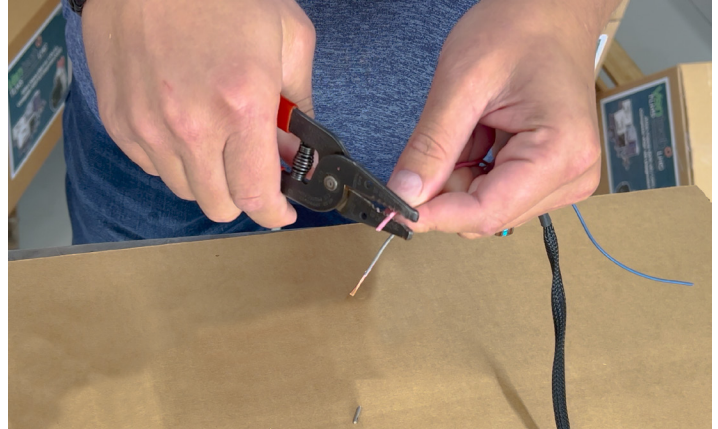

Using a crimper, connect the pink wires to each other and the gray wires to each other. Use a safe heat source to shrink the insulation on the splicers to make the connections water-tight.

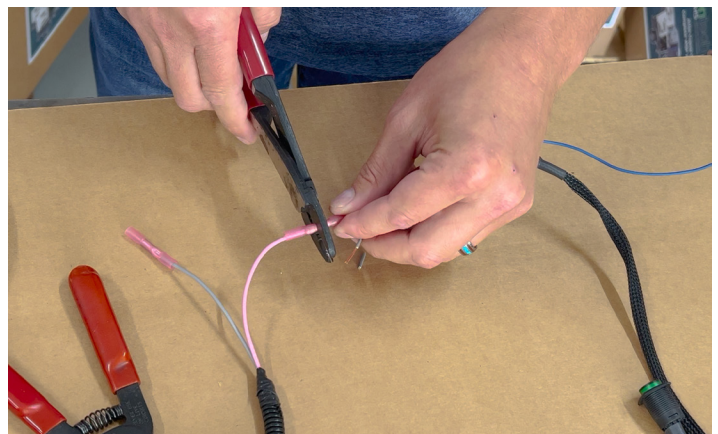



Locate the Fuse Tap (part #95-0060). This should include a pre-attached crimp connector (not shown here).

Also, locate the blue ignition wire from the Switch Wiring. If the blue wire has a crimp connector already attached (as shown) you will have to cut it off for this installation.

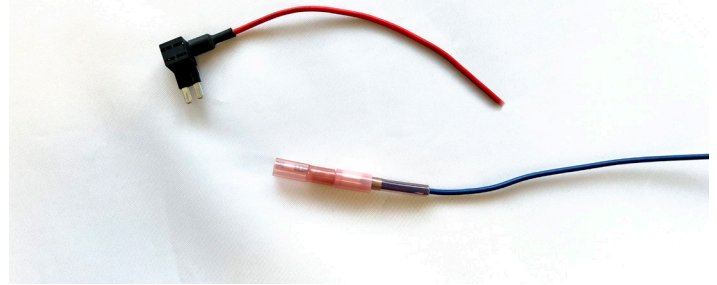

41. Open this Fuse Box

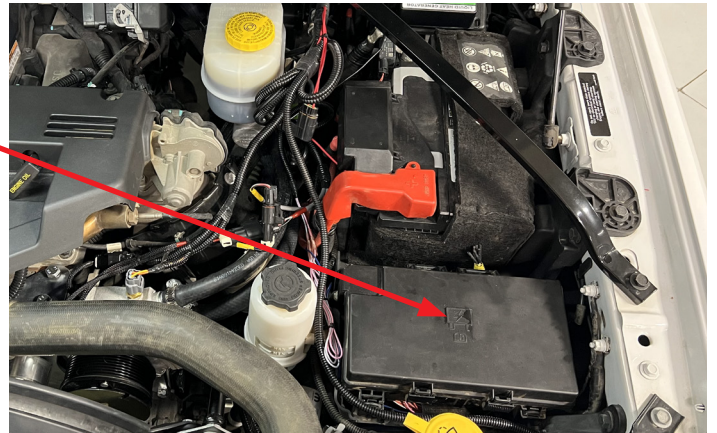

42. Locate the spare 20-amp fuse (F90/F91 Power Outlet / Batt Power Outlet / ACC). Remove this fuse.

We chose this location because it is normally unused and for accessories. If it is in use and uses greater than a 10-amp fuse you will have to identify a different switched location for the Tap.

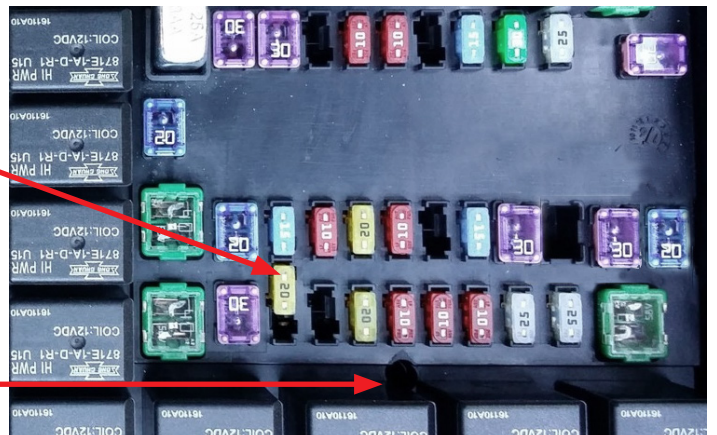

43. Snake the blue wire from the Switch Wiring up from the bottom of the Fuse Box using the access hole located here.



44. Trim about 1/4" of the insulation from the ends of the blue wire and the Fuse Tap and connect them with the Crimp Splicer.

45. Insert the 5 amp fuse (part # 96-0034) into the top position on the Fuse Tap and then insert the Fuse Tap into the ACC fuse location MAKING SURE IT IS IN LINE WITH THE OTHER FUSES as shown - not shifted up as the 20 amp fuse appears above.

**6.8 Reconnect both batteries.****6.9 Attach the LHG Wiring Harness to the driver side battery.**

Locate the power leads from the LHG Wiring Harness. Securely connect the Black one to battery negative and the Red one to the battery positive.

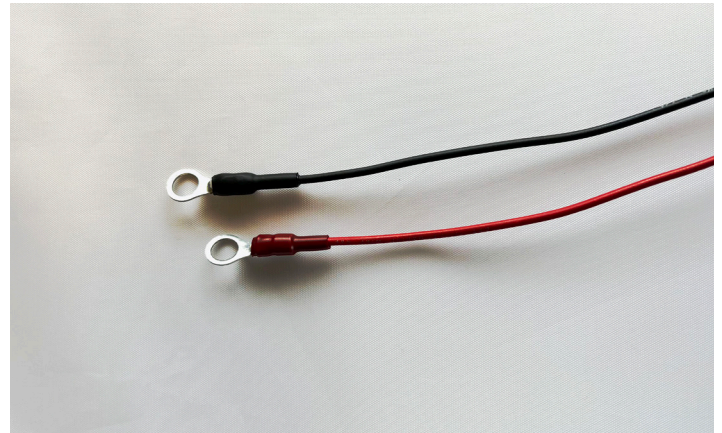
**6.10 Secure the Wiring Harness**

Using the remaining Nylon Tie Wraps (part #990-0002) and adding service loops where necessary, secure the LHG Wiring Harness away from any hot objects, sharp objects, or objects that may rub on the wires causing damage.

**6.11 Replace the Intake and the Fan/Intake Cover**

## 7. Final Inspection

- 46. Inspect installation for:
  - 47. Loose fasteners.
  - 48. Coolant leaks.
  - 49. Loose heater hose clamps.
  - 50. Pinched heater hoses.
  - 51. Loose wiring connections and battery connections.
  - 52. Ensure heater hoses are properly routed and protected against chafing and related damage.
  - 53. Ensure the wiring harness is routed properly and protected against chafing and related damage.
  - 54. Secure and dress harness using cable ties. Ensure that each harness termination point has some excess length to prevent unnecessary pulling on each connector.
  - 55. Make sure you have reinstalled all vehicle parts, panels, and components removed during LHG installation.
- 

**THE FOLLOWING PAGES CONTAIN  
IMPORTANT INFORMATION.**

**PLEASE READ  
BEFORE STARTING  
THE SYSTEM FOR THE FIRST TIME**



## 8. Initial Start-up

### 8.1 Initial startup behavior

#### 8.1.1 AIR PURGE

Firstly, the LHG ECU will disable the LHG for the first three (3) minutes of operation (engine idling). During these first three minutes, any air that may remain in the LHG coolant circuit will be purged from the system (air-purge).

During the Air-Purge all green LEDs on the ECU will cycle in sequence.

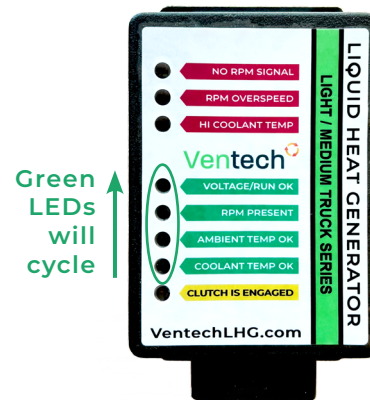

#### 8.1.2 BURNISHING

The second run-up sequence step is an automatic Burnishing of the LHG's electromagnetic clutch. This step also takes about three (3) minutes and must be performed at Idle. During this second run-up sequence, the electromagnetic clutch will be cycled (burnished) 50 times. This burnishing process cleans the clutch surfaces that may have residue build-up from the LHG's time in storage.

During the Burnishing the yellow LED on the ECU will blink on and off.

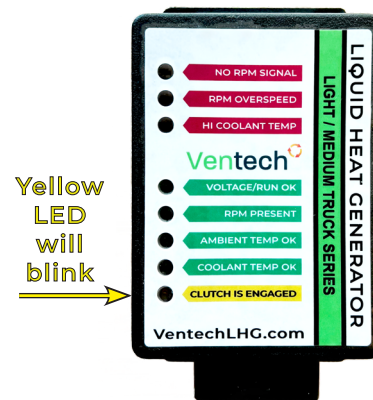

### 8.2 The first start

Start the vehicle engine and run at idle for ~6 minutes allowing the two run-up sequences to complete (air-purge and burnishing sequences).

### 8.3 Concluding the installation

While the engine is running, but after the two run-up sequences have been completed, check the following:

Hose connections for leaks.

Coolant level in the coolant recovery tank (add coolant as needed).

## Appendix A: The LHG ECU (Digital Controller) Strategy

The Electronic Control Unit is designed to determine when to engage and disengage the LHG (via the LHG electromagnetic clutch) depending on various parameters, including temperatures, RPMs, vehicle voltage, internal timers, and other conditions.

Note: RPMs referenced below are LHG RPM, not Engine RPM. Kit #400 (Ford HeatStroke LHG) has a 1:1.66 ratio between Engine RPM and LHG RPM.

To the right is a summary of the parameters and set-points that determine whether the LHG will engaged or disengaged.

ALL the engagement parameters must be met to activate the clutch, while ANY individual disengagement parameter will deactivate the clutch.

NOTE: When the LHG clutch disengages, it will not re-engage until:

All conditions required to engage the clutch are met as seen above and 2 to 5 seconds has elapsed after ALL engagement parameters have been met (time delay varies depending on parameter).

### Understanding the ECU LEDs during Normal Operation and as a Diagnostic Tool.

The Ventech ECU is equipped with 8 colored LEDs that indicate the operational status of the LHG heater system.

Three (3) LEDs are Red with corresponding descriptions (“No RPM Signal”, “RPM Overspeed”, and “Hi Coolant Temp”).

The Red LEDs are known as “Off-Flags”. Any illuminated Off-Flag will cause the LHG clutch to disengage.

LHG Clutch Engages WHEN ALL OCCUR SIMULTANEOUSLY	LHG Clutch Disengages IF ANY ONE OCCURS
LHG RPM greater than 255 RPM	LHG RPM less than 256 RPM
and	or
LHG RPM less than 2,600 RPM	LHG RPM greater than 6,000 RPM
and	or
LHG Temperature less than 167°F (75°C)	LHG Temperature greater than 185°F (85°C)
and	or
Supply Voltage is above 13.0V (5 second delay),	RPM signal is unstable (rate of change > 400)
and	or
Outside Ambient Temperature (OATS) is less than 50°F (10°C)	Voltage to ECU is below 12.0V
	or
	RPM-RPM Differential >150 RPM over 50 milliseconds
	or
	RPM-RPM Differential 50-150 RPM over 3 seconds

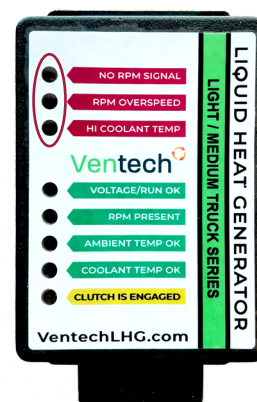

Four (4) LEDs are Green with corresponding descriptions (“Voltage/Run OK”, “RPM Present”, “Ambient Temp OK”, and “Coolant Temp OK”).

The Green LEDs are known as “On-Flags”. Every On-Flag must be illuminated for the LHG clutch to engage.

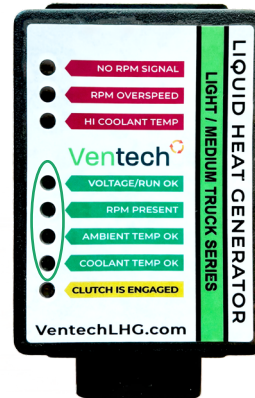

One (1) LED is Yellow: “Clutch Engaged” (LHG heater is engaged and producing heat).

The LEDs emulate the key parameters detailed in Figure 10. In order for the LHG to engage, ALL Green LEDs must be ON and ALL Red LEDs must be OFF.

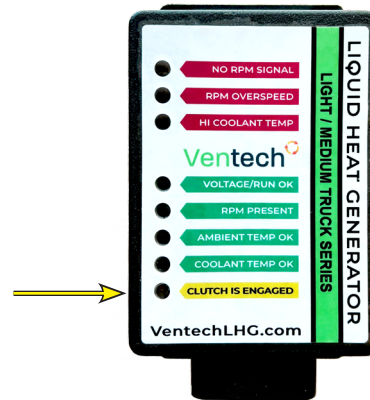

ECU LED Lights Defined

LED ON SOLID

- NO RPM SIGNAL (RPM less than 256)
- RPM OVERSPEED (LHG >6,000 / Engine >2,550)
- HI COOLANT TEMP (LHG Out Temp. >85°C / 185°F)
- VOLTAGE/RUN OK (Supply Voltage >13V)
- RPM Present (LHG >256 RPM)
- AMBIENT TEMP OK (Air Temp <10°C / 50°F)
- COOLANT TEMP OK (LHG Out Temp. <185°F / 167°F)
- CLUTCH IS ENGAGED (DC Clutch Voltage On)

LED FLASHING

Clutch is Burnishing

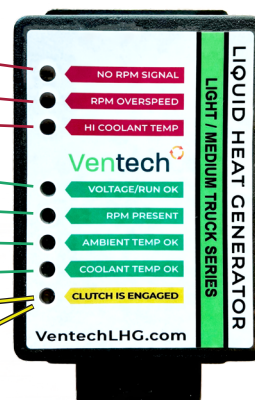



## Understanding the ECU LEDs for Diagnostics

As noted above, when on solid, the red LEDs are "off-flags" that indicate a situation where the LHG will be disengaged. This does not necessarily indicate an error condition, as there are many situations when the LHG should not be engaged. For instance when the Engine RPMs are too high or when the coolant temperature does not need to be supplemented.

Below are some specific LHG ECU error conditions the LED light sequence associated with each.

These error conditions will remain showing on the ECU until the ignition is turned off, which will cause the LHG ECU to reset.

### No Pulley RPM

The LHG Pulley and the LHG Clutch Rotor are independently monitored by the ECU to ensure that the LHG is running properly.

If the sensor for the Pulley fails, while the engine is running, the "NO RPM SIGNAL" LED will remain solidly on (other LEDs may be on as well) and the LHG will not engage.

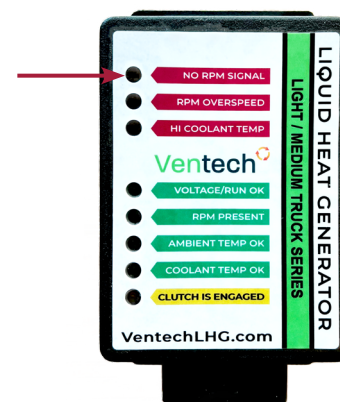

### No Rotor RPM

If the Rotor RPM sensor fails, the ECU will not be able to monitor for problems with the clutch. Should this occur the ECU will disengage and/or prevent engagement of the LHG.

If the sensor for the Rotor fails, the "NO RPM SIGNAL" LED and the "RPM PRESENT" LED will alternately and repeatedly blink on and off.

Should this situation occur, Contact Ventech for assistance. The LHG will cease to produce supplemental heat until the sensor is functional.

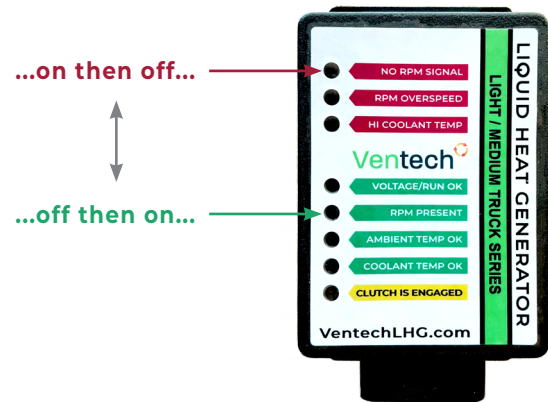

### Slipping Clutch

A slipping LHG clutch prevents proper LHG operation and can lead to other problems including belt failure. For this reason, the LHG ECU is programmed to recognize and remedy clutch slippage using an automated burnishing sequence.

The ECU will attempt to correct a slipping clutch up to 5 times during continuous operation. Should this automated burnishing fail to eliminate clutch slippage, the ECU is programmed to disengage the LHG as a safety precaution.

If there is repeated clutch slippage, all of the red LEDs and the all of the green LEDs will alternately and repeatedly blink on and off

Should this situation occur, Contact Ventech for assistance. The LHG will cease to produce supplemental heat until clutch slippage is corrected.

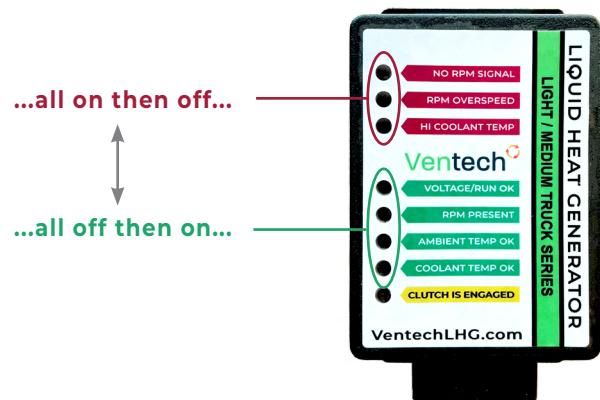

**Automatic Burnishing after extended periods of Non-Operation of the Vehicle.**

During vehicle storage, or other reasons for not operation of the LHG heater system over an extended period, the electromagnetic clutch plates of the LHG can become compromised by surface rust or debris collecting on the bare metal surfaces.

If ignored, the clutch performance may be compromised resulting in clutch slippage and part failure. The LHG ECU addresses this potential condition by performing a periodic burnishing routine based on the number of days that the LHG has not been operated.

This feature is fully automatic and requires no user-intervention. Automatic burnishing will occur at the intervals described below:

At the intervals shown Below, the automatic burnishing routine will start immediately after the vehicle's engine is started, irrespective of ambient air temperature.

WAIT for the burnishing routine to complete before driving the vehicle.

If the burnishing routine is interrupted before completion (engine stopped), the full burnishing routine will restart the next time the engine is started.

Interval of Non-Operation	Burnish Cycles (upon startup after interval)	Approximate time to complete
14 Days	50 Clutch Cycles	~ 1 Minute
100 Days	100 Clutch Cycles	~ 3 Minutes